

T-10 Meter

Sizes: 5/8", 3/4", and 1"

T-10 water meters are warranted for performance, materials, and workmanship.



Every T-10 water meter meets or exceeds the latest AWWA C700 Standard. Its nutating disc, positive displacement principle is time proven for accuracy and dependability since 1892, ensuring maximum utility revenue.

Construction

The T-10 water meter consists of three major assemblies: a register, an EnviroBrass® II maincase, and a nutating disc measuring chamber.

The T-10 meter is available with a variety of register types. For reading convenience, the register can be mounted in one of four positions on the meter.

The corrosion-resistant EnviroBrass II maincase will withstand most service conditions: internal water pressure, rough handling, and in-line piping stress.

The innovative floating chamber design of the nutating disc measuring element protects the chamber from frost damage while the unique chamber seal extends the low flow accuracy by sealing the chamber outlet port to the maincase outlet port. The nutating disc measuring element utilizes corrosion-resistant materials throughout and a thrust roller to minimize wear.

Warranty

Neptune provides a limited warranty with respect to its T-10 water meters for performance, materials and workmanship.

When desired, maintenance is easily accomplished either by replacement of major assemblies or individual components.

Systems Compatibility

Adaptability to all present and future systems for flexibility.

Key Features

■ Register

- Magnetic drive, low torque registration ensures accuracy
- Impact-resistant register
- High resolution, low flow leak detection
- Bayonet style register mount allows in-line serviceability
- Tamperproof seal pin deters theft
- Date of manufacture, size, and model stamped on dial face

■ EnviroBrass II Maincase

- Made from EnviroBrass II
- ANSI/NSF 61 Certified
- Lifetime guarantee
- Resists internal pressure stresses and external damage
- Handles in-line piping variations and stresses
- EnviroBrass II provides residual value vs. plastic
- Electrical grounding continuity

■ Nutating Disc Measuring Chamber

- Positive displacement
- Widest effective flow range for maximum revenue
- Proprietary polymer materials maximize long term accuracy
- Floating chamber design is unaffected by meter position or in-line piping stresses

T-10 Meter

Sizes: 5/8", 3/4", and 1"

5/8" Accuracy

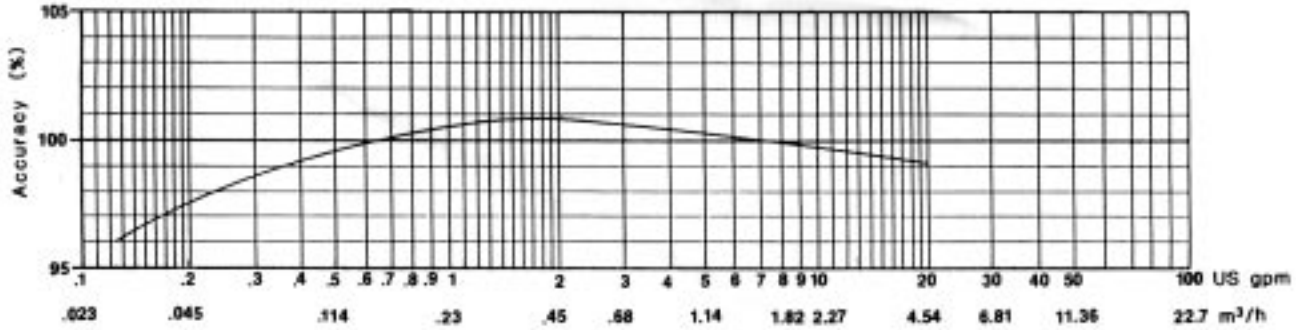

3/4" Accuracy

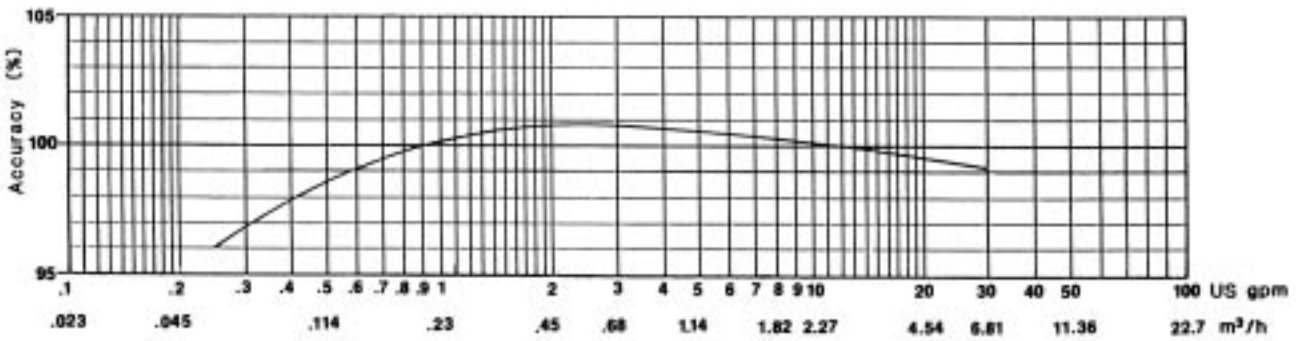

1" Accuracy

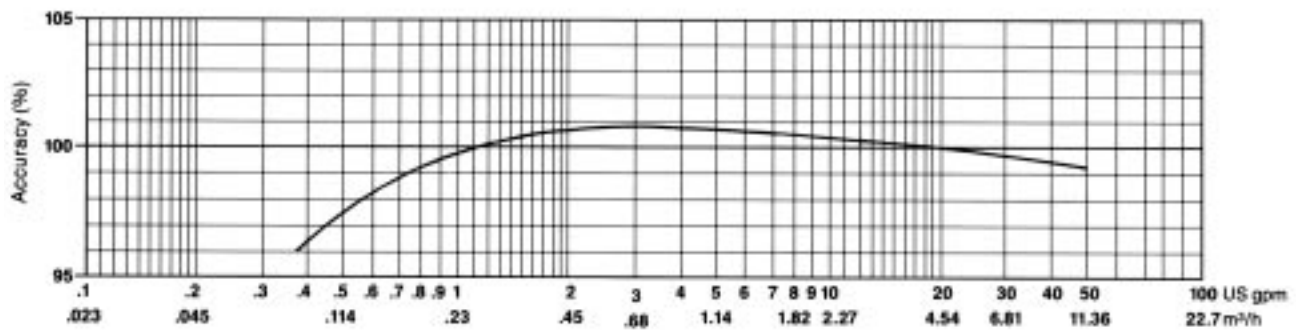

5/8" Pressure Loss

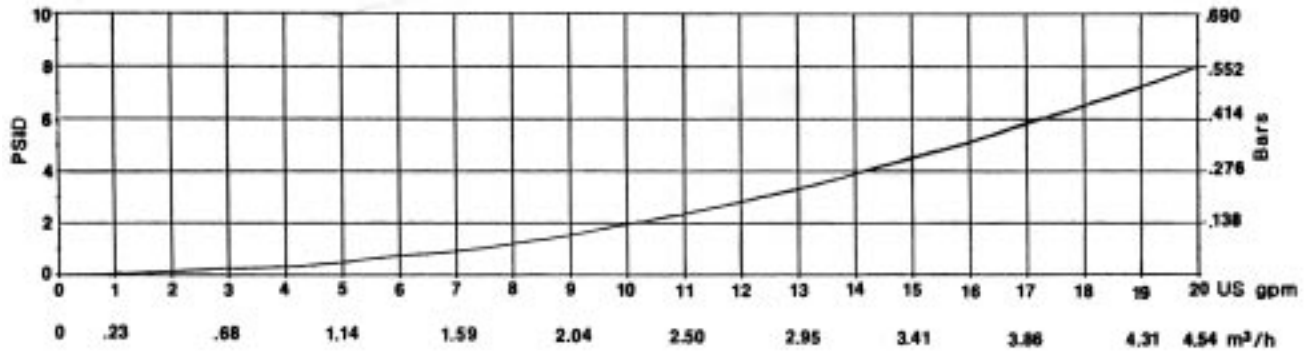

3/4" Pressure Loss

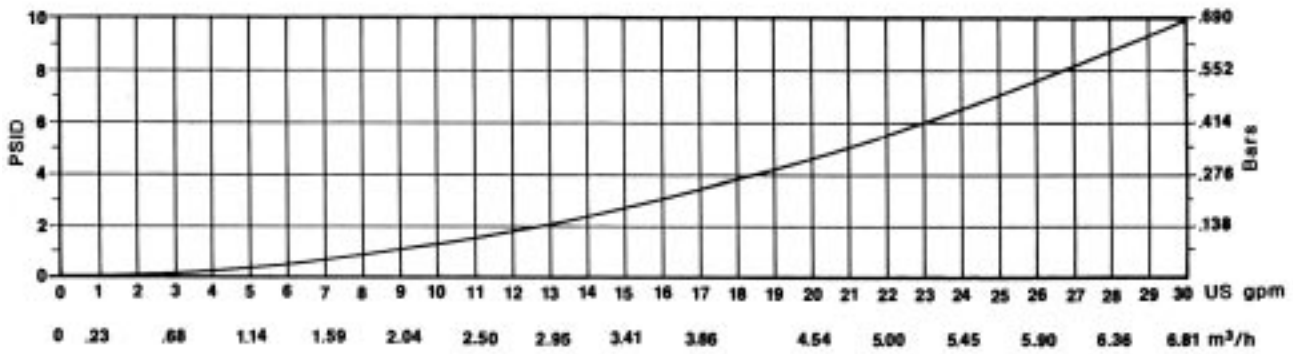

1" Pressure Loss

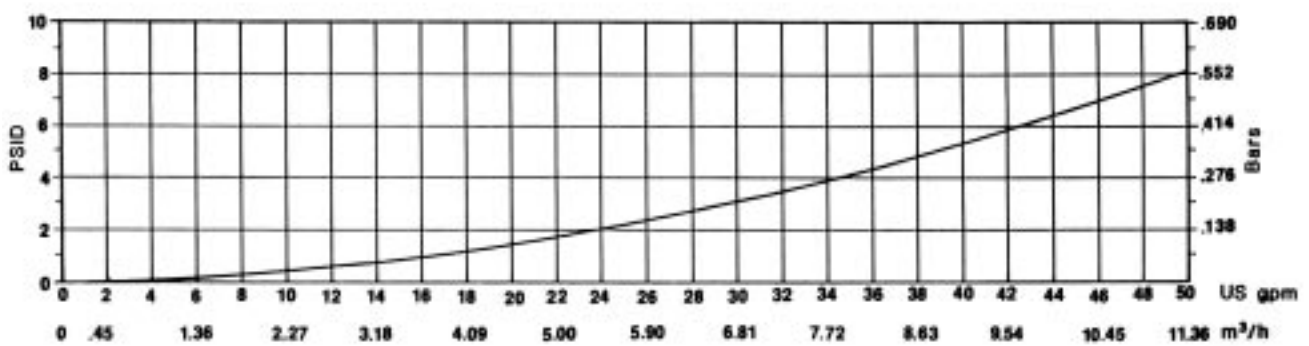

These charts show typical meter performance. Individual results may vary.

Operating Characteristics

Meter Size	Normal Operating Range @100% Accuracy (±1.5%)	AWWA Standard	Low Flow @ 95% Accuracy
5/8"	1/2 to 20 US gpm 0.11 to 4.55 m ³ /h	1 to 20 US gpm 0.23 to 4.5 m ³ /h	1/8 US gpm 0.03 m ³ /h
3/4"	3/4 to 30 US gpm 0.17 to 6.82 m ³ /h	2 to 30 US gpm 0.45 to 6.8 m ³ /h	1/4 US gpm 0.06 m ³ /h
1"	1 to 50 US gpm 0.23 to 11.36 m ³ /h	3 to 50 US gpm 0.68 to 11.4 m ³ /h	3/8 US gpm 0.09 m ³ /h

Registration

Registration (per sweep hand revolution)			
		5/8"	3/4" & 1"
10	US Gallons	✓	✓
10	Imperial Gallons	✓	✓
1	Cubic Foot	✓	✓
0.1	Cubic Metre	✓	✓
0.01	Cubic Metre	✓	

Register Capacity (6-wheel odometer)			
		5/8"	3/4" & 1"
10,000,000	US Gallons	✓	✓
10,000,000	Imperial Gallons	✓	✓
1,000,000	Cubic Feet	✓	✓
100,000	Cubic Metres	✓	✓
10,000	Cubic Metres	✓	

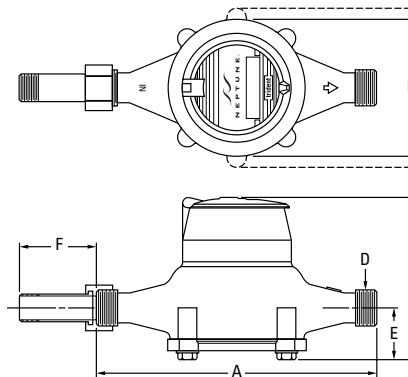

Dimensions

Meter Size	A	B	C-Std.	C-ARB	D-Threads	D-OD	E	F	Weight
	in/mm	in/mm	in/mm	in/mm	per inch	in/mm	in/mm	in/mm	lbs/kg
5/8"	7 1/2 191	3 5/8 92	4 7/8 124	5 3/8 137	14	1.030 26	1 5/8 41	2 1/2 64	3 3/4 1.7
5/8"x3/4"	7 1/2 191	3 5/8 92	4 7/8 124	5 3/8 137	11 1/2	1.290 33	1 5/8 41	2 5/8 67	4 1.8
3/4"	9 229	4 3/8 111	5 1/2 140	5 13/16 148	11 1/2	1.290 33	1 7/8 48	2 5/8 67	6 2.7
3/4"SL	7 1/2 191	4 3/8 111	5 1/2 140	5 13/16 148	11 1/2	1.290 33	1 7/8 48	2 5/8 67	5 1/2 2.5
3/4"x1"	9 229	4 3/8 111	5 1/2 140	5 13/16 148	11 1/2	1.626 41	1 7/8 48	2 3/4 70	6 1/2 2.9
1"	10 3/4 273	6 1/2 165	6 3/8 162	6 5/8 168	11 1/2	1.626 41	2 1/8 54	2 3/4 70	9 3/4 4.4
1"x1 1/4"	10 3/4 273	6 1/2 165	6 3/8 162	6 5/8 168	11 1/2	1.865 47	2 1/8 54	2 13/16 71	10 1/4 4.6

Guaranteed Systems Compatibility

All T-10 water meters are guaranteed adaptable to our ARB®V, ProRead AutoDetect, TRICON®/S, TRICON/E3®, and Neptune meter reading systems without removing the meter from service.

Specifications

- Certification: ANSI/NSF 61
- Application: cold water measurement of flow in one direction
- Maximum operating pressure: 150 psi (1034 kPa)
- Maximum operating temperature: 80°F
- Measuring chamber: nutating disc technology design made from proprietary synthetic polymer

Options

- Sizes:
 - 5/8", 5/8" x 3/4"
 - 3/4", 3/4" SL, 3/4" x 1"
 - 1", 1" x 1 1/4"
- Units of measure: U.S. gallons, imperial gallons, cubic feet, cubic metres
- Register types:
 - Direct reading: Bronze box and cover (standard)
 - Remote reading: ProRead AutoDetect Absolute Encoder, TRICON/S, TRICON/E3
 - Reclaim
- Bottom caps:
 - Synthetic polymer (5/8" only)
 - Cast iron
 - EnviroBrass II, ductile iron
- Connections: EnviroBrass II, straight or bent



Distributed by:

Follin Flo-Controls
 39 magnolia Ave., Cambridge, MA 02138
 Tel: (617) 290-2134 Web: www.FollinFlo-Controls.com
 Fax: (240) 250-8907