

Fluxi 2000/TZ

Turbine Gas Meter

- ▶ **PTB approved with only 2 DN inlet straight pipe, 0 (zero) DN outlet pipe even with severe perturbations**
- ▶ **Go beyond compliance with all current European and International Standards**
- ▶ **Reduced pressure loss for low pressure network**
- ▶ **Excellent high-pressure behaviour**
- ▶ **IP 67 protection of the totaliser**
- ▶ **Various options available: integrated thermowells, oil pump, pulse transmitters, etc**



- ▶ **Turbine Gas Meter Fluxi 2000/TZ DN300 ANSI600 G4000 fitted with an integrated flow conditioner**

Turbine gas meters are flow meters. The flow of gas turns a turbine wheel, and thus, the rotating speed of the turbine is proportional

Applications

Fluxi 2000/TZ meters are designed to measure natural gas, and various filtered, and non-corrosive gases. They are used to measure medium to high gas flow, at low, medium or high pressure.

to the linear speed of the gas.

The movement is mechanically transmitted to the totaliser through the magnetic coupling.

The Fluxi 2000/TZ meters have been optimised for use in all applications related to the transportation and distribution of gas. Fluxi 2000/TZ meters are approved for fiscal use.

Features

Metrological approvals	EC (PTB): 1.33-3271.51-ROM-E04.	
Intrinsic safety approval	LCIE 02 ATEX 6255 X - Compliant with the Directive 94/9/EC	
Flow rate	From 8 m ³ /h to 10000 m ³ /h, G65 to G6500.	
Nominal diameters	From DN50 to DN500 mm (2" to 20").	
Maximum working pressure	up to 100 bar depending on the body material and flanging.	
Mounting	The Fluxi 2000/TZ meters can be installed either horizontally or vertically, for the DN50 to DN300, and horizontally for the DN400 and DN500.	
Body materials	Ductile iron, cast steel or welded steel. Compliant with the Pressure Equipment Directive 97/23/EC	
Temperature range	Ambient:	-20°C to +60°C
	Gas:	-20°C to +60°C
	Storing temperature:	-40°C to +70°C

Description

The Fluxi 2000/TZ meter is composed of five main parts:

- a body containing all the components (1);
- a flow straightener to stabilise and accelerate the gas flow before the turbine wheel (2);
- a measuring unit including the turbine wheel (3);
- a magnetic coupling to transmit the movement of the turbine wheel to the totaliser (4);
- a totaliser to register the measured gas (5).

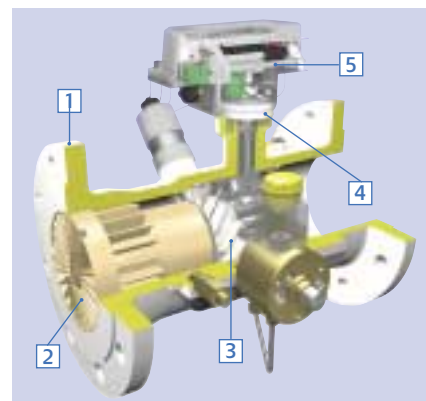



► Turbine Gas Meter Fluxi 2000/TZ
DN80 ISO PN16 G160

Metrology

In accordance with EC and OIML standards. Depending on the G size and the DN, the meters are available with EC approval 1:20. Rangeability of 1:30, depending on the G size, is available as an option with a national approval. According to the PTB TR G7, for high-pressure tests, the rangeability can be extended to 1:50, depending on the pressure.

In line with EC standards, the maximum permissible error is $\pm 2\%$, from Q_{min} to $0.2 Q_{max}$, and $\pm 1\%$ from $0.2 Q_{max}$ to Q_{max} . The WME (Weighted Measured Error) is less than 0.4%. Typical Actaris accuracy is $\pm 1\%$ from Q_{min} to $0.2 Q_{max}$, $\pm 0.5\%$ from $0.2 Q_{max}$ to Q_{max} .

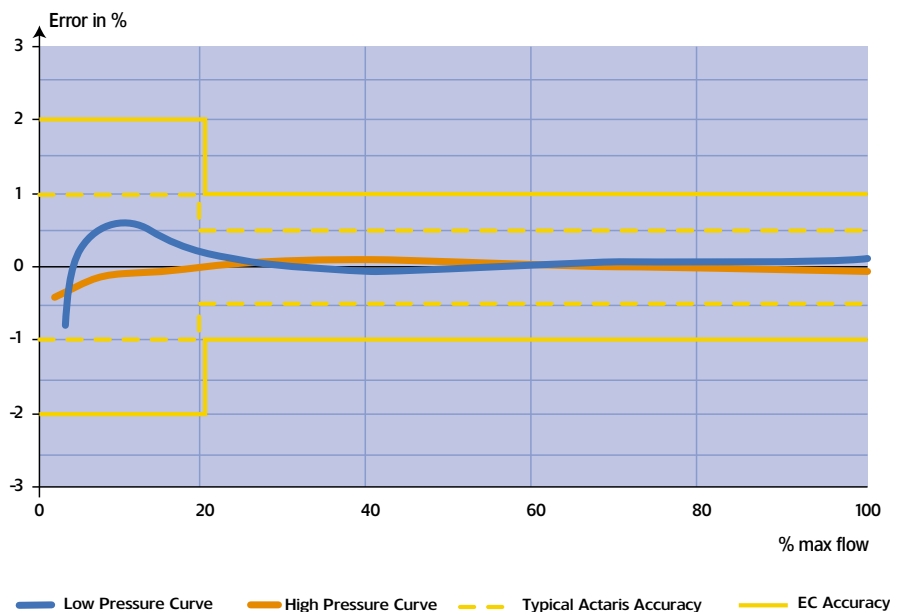

Totaliser:

- 8-digit index
- IP67 protection
- UV resistant cover
- Equipped with a built-in silicagel cartridge; as an option, equipped with an external cartridge to enable easy maintenance even in extreme conditions
- Free adjustable totaliser
- Fitted with a reflecting disc on the first drum
- Integrated optical disc to facilitate the periodic calibration of the meter
- Equipped with a magnet to allow the possibility of retrofitting an external LF
- Customised name plate (logo, customer serial number...)
- Unit: m^3 or Cf^3 .

Transmitters

- 1 Low Frequency (LF): Two LF Reed switches are fitted as standard on the whole range.
Anti-tampering (AT): this device is fitted as standard on the whole range.
- 2 Inductive LF is supplied as an option.
- 3 Medium Frequency (MF): one transmitter is supplied as an option.

Oil Pump

An oil pump is supplied as an option, which lubricates the main ball bearings in the measuring unit.

The oiling can be done even when the meter is under pressure.

Turbine Wheel

This is the most important component of the meter for achieving high accuracy at low and high pressure. It can be made from aluminium for the whole range or in polyacetal for the DN \leq 200.

Depending of the G size, the blades of the turbine wheel are oriented at 45° or 60°.

Turbine wheel at 60° is used to avoid over-speed of the wheel

Pressure Tapping

This device allows the gas pressure to be measured at the reference point. It is installed as standard. The standard pressure tapping is an Ermeto 6 mm.

Flow Straightener

This device stabilises and accelerates the flow before the turbine wheel. It has been designed to meet the requirements of the 2 perturbation tests defined in the EN12261 (low level and high level perturbation).

All DN meet the requirements of the low level perturbation test without an additional device with only 2 DN inlet straight pipe, 0 DN outlet of the meter.

From DN80 to DN150, no additional device is required to fulfil the high level perturbation test with only 2 DN inlet, 0 DN outlet of the meter.

- 4 One External Reed switch can be retrofitted without decommissioning the meter.
- 5 High Frequency (HF): up to 3 transmitters are supplied as an option on the whole range: 2 fitted close to the turbine wheel (HF3), and 1 close to a reference wheel (HF2). (Only one HF3 can be installed on the G65 DN50).



► Oil pump



► Turbine wheel

When a HF3 is requested, the wheel must be in aluminium.

For high pressure use, or for measuring dirty gases, an aluminium wheel is recommended.

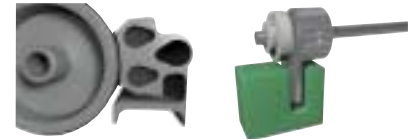

► 1

► 2



► 3



► 4



► 5

Options:

Extension for the totaliser

This option allows the possibility of increasing the distance between the body of the meter and the index, to facilitate the reading when the meter is covered with ice due to measurement of gas at low temperatures.



► Extension for the totaliser

Measurement of aggressive gases

A version with a PTFE (Teflon) coating is available, as an option.



► Fluxi 2000/TZ with PTZ CORUS

Accessories

Bracket for mounting a volume converter

This device allows the Actaris PTZ volume converter to be adapted directly onto the meter.

Thermowells

This device allows the temperature of the measured gas to be read at the reference point, downstream of the turbine. As an option, the meter can be prepared for the installation of two thermowells in our factory and the devices inserted. If the meter has been prepared like this, the thermowells can be retrofitted without recalibration of the meter (defined in the type approval).

Flow conditioner

For DN50 to DN200, a flow conditioner can be supplied for installation between 2 RF flanges in front of the meter, to further enhance the performance of the meter when subjected to severe perturbation. For DN200 to DN400 (3 x DN meters only), The flow conditioner can be retrofitted directly in the inlet of the flow straightener. The integration of the flow conditioner in the meter provides a very compact solution without need for any extra flanging.

External silicagel cartridge

This accessory is used to carry out maintenance on the installed external silicagel cartridge in extreme conditions.



► Fluxi 2000/TZ DN200 ISO PN16 G1000 fitted with an integrated flow conditioner

Characteristics

A) Technical data sheet Rangeability and pulse values

					With the correction gears 32/40 (correction 0%)						
G size	DN	Max Flow	Rangeability	1 Imp LF	1 Imp MF	Freq MF at Qmax	1 Imp HF2	Freq HF2 at Qmax	1 Imp HF3	Freq HF3 at Qmax	RPM
	(mm)	(m ³ /h)	(1)	(m ³ /Imp)	(dm ³ /Imp)	(HZ)	(dm ³ /Imp)	(HZ)	(dm ³ /Imp)	(HZ)	(Rot. Per Min.)
G65	50	100	10	0.1	5.29655	5.24	-	-	0.00871	3188	15939
G100	80	160	20	1	22.85714	1.94	0.07521	591	0.03760	1182	5910
G160		250	20 or 30		22.85714	3.04	0.07521	923	0.03760	1847	9334
G250		400	20 or 30		39.72414	2.80	0.13071	850	0.06535	1700	8501
G160	100	250	20	1	22.85714	3.04	0.06211	1118	0.06211	1118	4193
G250		400	20 or 30		22.85714	4.86	0.06211	1789	0.06211	1789	6708
G400		650	20 or 30		39.72414	4.55	0.10795	1673	0.10795	1673	6272
G400	150	650	20	1	22.85714	7.90	0.15238	1185	0.15238	1185	3555
G650		1000	20 or 30		22.85714	12.15	0.15238	1823	0.15238	1823	5469
G1000		1600	20 or 30		39.72414	11.19	0.26483	1678	0.26483	1678	5035
G650	200	1000	20	10	228.5714	1.22	0.37303	745	0.37303	745	2334
G1000		1600	20 or 30		228.5714	1.94	0.37303	1191	0.37303	1191	3574
G1600		2500	20 or 30		397.2414	1.75	0.64829	1071	0.64829	1071	3214
G1000	250	1600	20	10	228.5714	1.94	0.57319	775	0.57319	775	1939
G1600		2500	20 or 30		228.5714	3.04	0.57319	1212	0.57319	1212	3029
G2500		4000	20 or 30		397.2414	2.80	0.99617	1115	0.99617	1115	2789
G1600	300	2500	20	10	218.9474	3.17	0.86064	807	0.86064	807	1729
G2500		4000	20 or 30		218.9474	5.07	0.86064	1291	0.86064	1291	2767
G4000		6500	20 or 30		397.2414	4.55	1.56148	1156	1.56148	1156	2478
G2500	400	4000	20	10	218.9474	5.07	2.05391	541	2.05391	541	1159
G4000		6500	20 or 30		218.9474	8.25	2.05391	879	2.05391	879	1884
G6500		10000	20 or 30		397.2414	6.99	3.72647	745	3.72647	745	1597
G4000	500	6500	20 or 30	10	218.9474	8.25	2.05391	879	2.05391	879	1884
G6500		10000	20 or 30		397.2414	6.99	3.72647	745	3.72647	745	1597

(1) For greater than 1:20, refer also to your National Approval.

A: Ductile iron EN-GJS-400-15 (GGG40)
 B: Steel (Cast steel GS or welded steel)
 (1) Thermowells and HF2 not available
 (2) HF2 not available, model available under specific conditions

Note: for the pressure and temperature range of the body material, please check your National Rules

Body materials and approximate weight (Kg)

DN (mm)	Length of body (mm)	ISO PN 10-16	ISO PN 20	ISO PN 25	ISO PN 40	ISO PN 50	ISO PN 110	ANSI 150	ANSI 300	ANSI 600
50	150	A ⁽¹⁾ 8	A ⁽¹⁾ B ⁽¹⁾ 8	A ⁽¹⁾ 8	A ⁽¹⁾ 8	B ⁽²⁾ 11	B ⁽²⁾ 11	A ⁽¹⁾ B ⁽¹⁾ 8	B ⁽²⁾ 11	B ⁽²⁾ 11
80	240	AB 19	AB 19	AB 19	AB 19	B 30	B 37	AB 19	B 30	B 37
100	300	AB 22	AB 22	B 25	B 25	B 45	B 55	AB 22	B 45	B 55
150	335	A ⁽¹⁾ B ⁽¹⁾ 46	A ⁽¹⁾ B ⁽¹⁾ 46	B ⁽¹⁾ 46	B ⁽¹⁾ 46	-	-	A ⁽¹⁾ B ⁽¹⁾ 46	-	-
150	450	AB 54	AB 54	B 54	B 54	B 80	B 95	AB 54	B 80	B 95
200	400	B ⁽¹⁾ 72	B ⁽¹⁾ 72	B ⁽¹⁾ 72	B ⁽¹⁾ 95	-	-	B ⁽¹⁾ 72	-	-
200	600	AB 83	AB 83	B 83	B 110	B 130	B 150	AB 83	B 130	B 150
250	400	B ⁽¹⁾ 106	B ⁽¹⁾ 106	B ⁽¹⁾ 106	B ⁽¹⁾ 125	-	-	B ⁽¹⁾ 106	-	-
250	750	B 120	B 120	B 120	B 140	B 220	B 245	B 120	B 220	B 245
300	900	B 190	B 190	B 190	B 220	B 265	B 265	B 190	B 265	B 295
400	1200	B 440	B 440	B 440	B 490	B 680	B 740	B 440	B 680	B 740
500	1500	B 580	B 580	B 580	B 640	B 770	B 950	B 580	B 770	B 950

B) Pressure loss of the Fluxi 2000/TZ meters

G size	DN (mm)	Max. Flow (m³/h)	Pressure losses of the Fluxi 2000/TZ meter (mbar)	
			Standard ΔPr	With integrated flow conditioner ΔPr
			ρ=0.83kg/m³, T=0°C, Qmax	
G65	50	100	9.1	-
G100	80	160	2.4	-
G160		250	5.9	
G250		400	12.8	
G160	100	250	2.2	-
G250		400	5.4	
G400		650	11.8	
G400	150	650	2.7	-
G650		1000	6.6	
G1000		1600	13.8	
G650	200	1000	1.6	2.6
G1000		1600	4.0	6.3
G1600		2500	8.7	13.7
G1000	250	1600	2.1	3.3
G1600		2500	5.0	8.0
G2500		4000	11.0	17.3
G1600	300	2500	2.0	3.2
G2500		4000	5.0	7.8
G4000		6500	9.5	17.0
G2500	400	4000	1.8	2.8
G4000		6500	4.4	6.8
G6500		10000	9.5	14.9
G4000	500	6500	4.4	6.8
G6500		10000	9.5	14.9

Where:

- Δp: Pressure loss in the calculated conditions
 Δp_r: Pressure loss in the reference conditions
 ρn: Gas density (kg/m³) at 0°C and 1013 mbar
 P_b: Operating pressure (Bar gauge)
 q: Flow rate (m³/h)
 Q_{max}: Maximum flow rate (m³/h)
 T_b: Gas temperature (°C)

Calculation of pressure loss:

$$\Delta p = \Delta p_r \times \frac{\rho n}{0.83} \times (P_b + 1) \times \left[\frac{q}{Q_{max}} \right]^2 \times \left[\frac{273}{(273 + T_b)} \right]$$

C) Dimensions (mm)

DN	A	B	B short*	C	C short*	D	E	L	L short*
50	180	60	-	45	-	125	170	150	-
80	250	100	-	60	-	150	175	240	-
100	280	125	-	85	-	175	190	300	-
150	285	185	92	125	101	205	200	450	335
200	325	240	101	175	150	230	235	600	400
250	350	330	106	275	120	300	265	750	400
300	380	300	-	300	-	300	295	900	-
400	500	400	-	550	-	350	345	1200	-
500	500	500	-	750	-	390	378	1500	-

*Short version, same length as for the former NM meter

D) Thermowells sizes

DN	Thread	Order Number with PG screw, o-ring	d bore (z) mm	d Cable mm	Max. Setting Depth (S) Sensor (mm)	L mm	X mm
80/100	G 1/4 A	E952-014-04	7.5	4-8	60	59	12
50/150/200	G 1/4 A	E952-014-14	7.5	4-8	90	93	12
250/500	G 1/2 A	E952-014-05	8	4-8	150	147	14

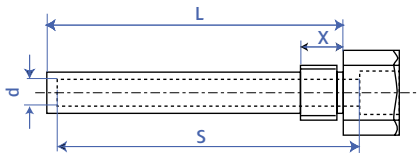

► Thermowell fitted with sealing holes

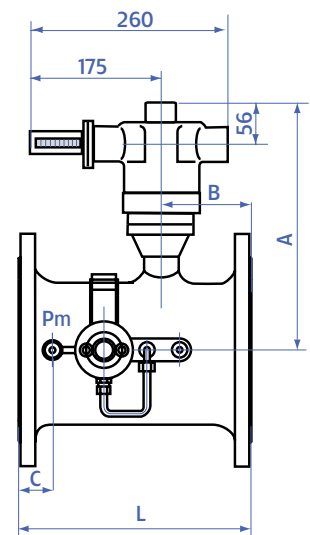
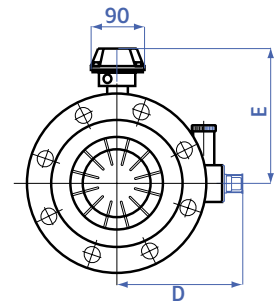
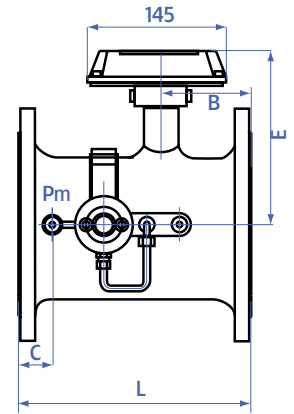

E) Transmitter characteristics

Intrinsic safety approval: N° LCIE 02 ATEX 6255X

Low Frequency pulse transmitter (LF):

The LF transmitter consists of 2 dry Reed switches, normally open, and controlled by a magnet situated in the first drum of the totaliser. The LF connections are without polarity.

Characteristics of LF transmitter:

- ▶ Intrinsic safety level:
⊕ II 1/2G EEx ia IIC T5
- ▶ Hermetically sealed contacts
- ▶ Maximum terminal voltage: 30 Volt and maximum current according to EN50020, as example:
 - 30 Volt - 101 mA
 - 24 Volt - 174 mA
 - 18,5 Volt - 402 mA
- ▶ Maximum temperature: +60°C
- ▶ Minimum pulse time: 0.4 sec

Anti-tampering transmitter (AT):

This consists of one dry Reed switch, normally closed. Attempts at magnetic tampering will open the contact. The electrical characteristics are the same as those for the LF transmitter.

Inductive transmitters (MF and HF):

They are inductive sensors actuated by a toothed disc. The frequency is proportional to the instantaneous flow. The polarity of the connections is indicated on the name plate of the meter.

Characteristics of transmitters:

- ▶ Intrinsic safety level:
⊕ II 1/2G EEx ia IIC T5
- ▶ Proximity detector conform to EN50227 (and NAMUR) standards
- ▶ They conform to CENELEC standards (EN50014 and 50020) with
 - $U_i \leq 15$ Volt
 - $I_i \leq 50$ mA
 - $P_i \leq 120$ mW
- ▶ Maximum temperature: + 60°C

F) Installation

Each meter is delivered with binder plugs for the installed transmitters and oil when an oil pump is installed.

Please refer to the instruction manual supplied with the meter.

The advice given therein will ensure optimal use of the Fluxi 2000/TZ meter over the years.

Distributed by:

Follin Flo-Controls

Cambridge, MA / Norwalk, CT USA

www.FollinFlo-Controls.com

Tel: 617-290-2134 / 203-845-0593

Fax: 240-250-8907 / 203-846-3825